







+J02001.3_P
SNAIL ADVENTURE RIDER



Dimensions	 Safety area	 Impact area	 Falling height HIC	 Physical footprint	 Number of users
	3,1 x 2,5 m	0 mq	90 cm	1,1 x 0,5 x 0,8 m	2

Characteristics	 stainless steel screws	 use under surveillance

Age range
From 2 to 12 years

Materials

Plan

Picture

Manufacturer
Pozza 1865 S.R.L.

Country of manufacturing

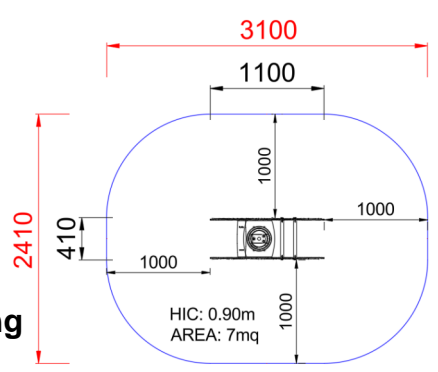

Area di sicurezza totale / Total safety area: 7mq
Altezza Max di Caduta / Max falling height: 0.90m

Components list



JMOLLA - SPRING
NR 1 STAINLESS STEEL SPING FOR
SPRING GAME