

+U0600.820_ALU
PANNELLO AEREO

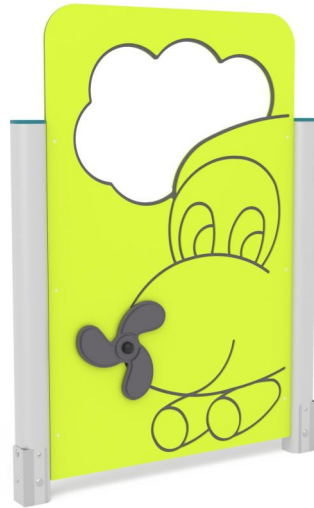

Dimensions	Safety area	Impact area	Falling height HIC	Physical footprint	Number of users
	4,1 x 3,1 m	0 mq	60 cm	1,1 x 0,9 x 1,3 m	2

Characteristics



Age range

Da 2 a 12 anni

Materials



Made of EN EV6060 anodized aluminium 9x9cm custom mold with rounded edges, minimum thickness 2,7mm



Plan

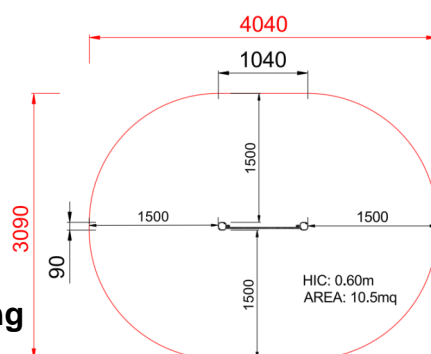

Picture



Manufacturer

Pozza 1865 S.R.L.

Country of manufacturing

ITALY



Area di sicurezza totale / Total safety area: 10.5mq
Altezza Max di Caduta / Max falling height: 0.60m