

+AF102.POLY100_ALU

MERLINO CON SCIVOLO E ARREDO - FANTASY



Dimensions



Safety area

7,1 x 9,1 cm



Impact area

27.5 mq



Falling height HIC

140 cm



Physical footprint

3,8 x 5,1 x 3,3 cm



Number of users

16

Characteristics

Age range

3-12

Materials



Plan

Picture

Manufacturer

Pozza 1865 S.R.L.

Country of manufacturing

ITALY



Components list



**xABACOU0600-S_ALU - NG Mirror
MAGIC Panel**

NR 1 Made of polyethylene, with mirror made polished stainless steel.



xBV-3_ALU - NG Galaxy panel

NR 1 Vertical panel made of polyethylene

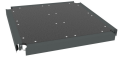

**xC2_ALU - NG Square platform, under
tower**

NR 1 Made of non slip material.



**xGT-04_ALU - NG Furniture under the
tower-2**

NR 1 1 small table and 1 corner bench in polyethylene. Support made of a galvanized steel.

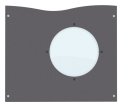

**xP-2_ALU - NG Protection lateral
panels with polycarbonate portholes**

NR 2 Made of polyethylene, with polycarbonate portholes, provided with stainless steel brackets for fixing them to the tower.

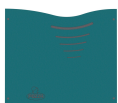

**xP-7.1_ALU - NG Simple Turquoise
Panel**

NR 1 .



xPAL-03_ALU - NG Turning Gym

NR 1 ...



**xQT12-9_ALU - NG Square tower h90
cm**

NR 1 .



**xQT4-14_ALU - NG Square tower h140
cm Fantasy**

NR 1 Composed of 4 posts having a 9 x 9 mm section by aluminium, 1 square platform placed at a height of 140 cm. Coloured polyethylene gable roof



**xS-9_ALU - NG Climbing ladder h90
cm Fantasy**

NR 1 made of aluminium, complete with handrails and protective panels made of polyethylene



**xSVPX-14_ALU - NG Straight slide
h140 cm Fantasy**

NR 1 slide with lateral sides made of polyethylene and stainless steel slide certified according to the existing rules; starting platform height 140 cm; provided with a transversal bar.

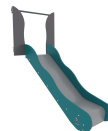

**xSVPX-9_ALU - NG Straight slide h90
cm Fantasy**

NR 1 slide with lateral sides made of polyethylene and stainless steel slide certified according to the existing rules; starting platform height 90 cm; provided with a transversal bar.